

SOLUZIONE

*aria*

BOCCHETTE MANDATA

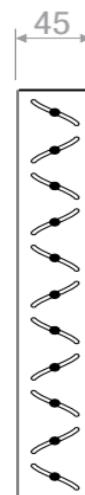
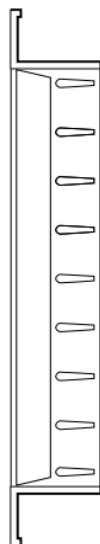
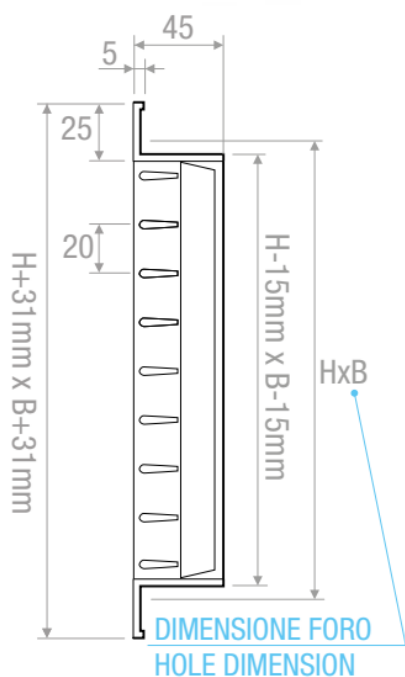
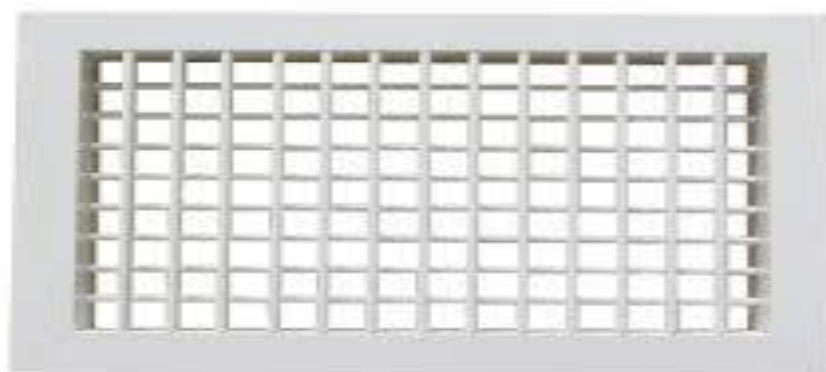

Alette frontali parallele al lato lungo, posteriori parallele al lato corto

Alette frontali parallele al lato corto, posteriori parallele al lato lungo (VERSIONE STANDARD)

Serranda di taratura

TIPO DI FISSAGGIO - TYPE OF FIXING

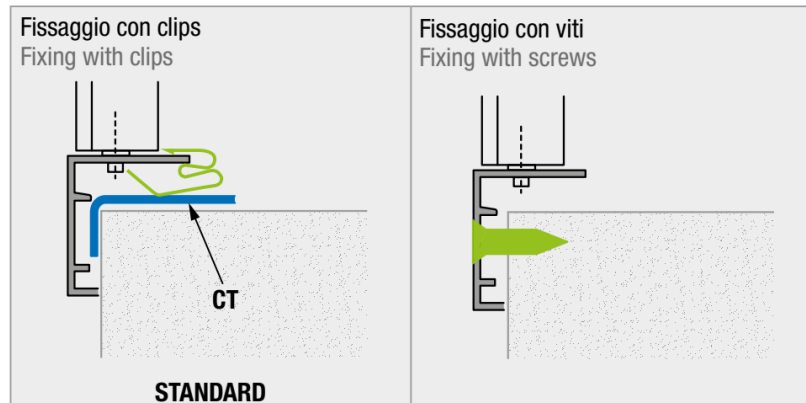

FORI - HOLE

2 Fori - Holes

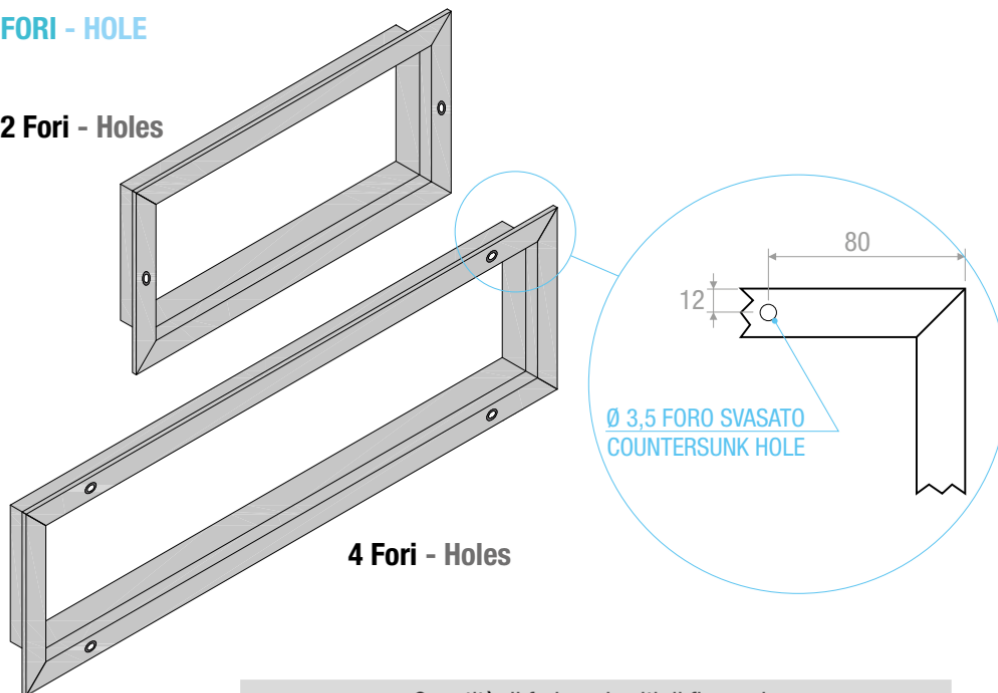

4 Fori - Holes

Quantità di fori per le viti di fissaggio  
Amount of holes for mounting screw

Lato minore Smaller side	Lato maggiore - Longer side				
	200	250	300	350	≥400
100	2	2	2	4	4
150	2	2	2	4	4
200	2	2	2	4	4
≥250	2	2	2	4	4

DIAGRAMMA SCELTA RAPIDA - QUICK SELECTION DIAGRAM

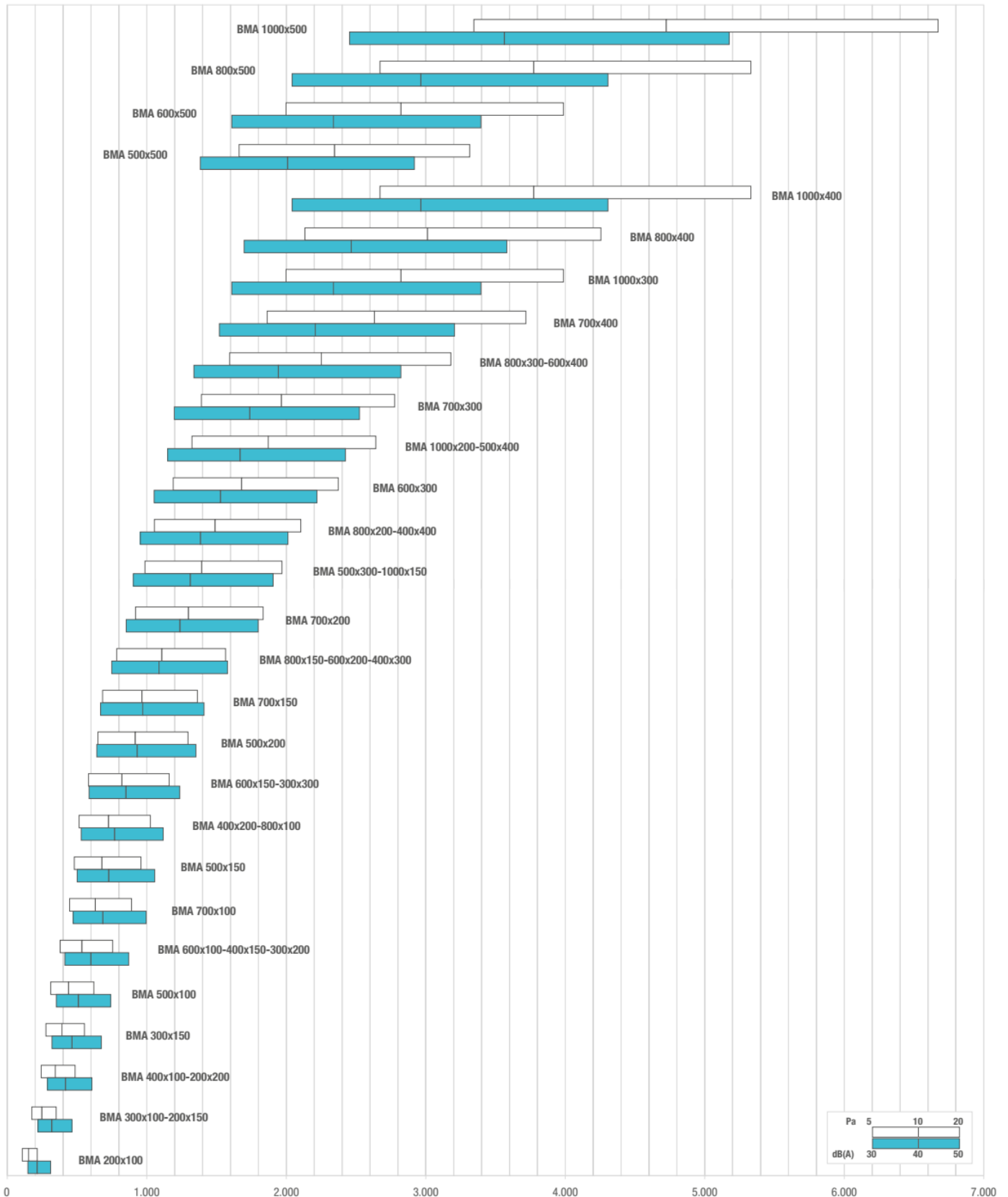

SOLUZIONE

*aria*

BOCCHETTE MANDATA

TABELLA DI SELEZIONE - SELECTION TABLE

Modello - Model	A <sub>s</sub> [m²]	Q [m³/h]		L <sub>wa</sub> [dB(A)]		X <sub>0,25</sub> [m]		Dp <sub>t</sub> [Pa]	
		min	max	min	max	min	max	min	max
<b>BMA 200x100</b>	0,0088	110	220	22	41	2,4	4,8	5	20
<b>BMA 300x100-200x150</b>	0,0144	180	350	25	42	3,1	6,0	5	20
<b>BMA 400x100-200x200</b>	0,0200	240	490	25	44	3,5	7,2	5	20
<b>BMA 300x150</b>	0,0228	280	550	26	45	3,8	7,5	5	20
<b>BMA 500x100</b>	0,0256	310	620	27	45	4,0	8,0	5	20
<b>BMA 600x100-400x150-300x200</b>	0,0311	380	760	28	46	4,5	8,9	5	20
<b>BMA 700x100</b>	0,0367	450	890	29	47	4,9	9,6	5	20
<b>BMA 500x150</b>	0,0395	480	960	29	47	5,0	10,0	5	20
<b>BMA 400x200-800x100</b>	0,0423	510	1030	29	48	5,1	10,4	5	20
<b>BMA 600x150-300x300</b>	0,0479	580	1160	30	48	5,5	11,0	5	20
<b>BMA 500x200</b>	0,0534	650	1300	30	49	5,8	11,6	5	20
<b>BMA 700x150</b>	0,0562	680	1360	30	49	5,9	11,9	5	20
<b>BMA 800x150-600x200-400x300</b>	0,0646	780	1570	31	50	6,3	12,8	5	20
<b>BMA 700x200</b>	0,0757	920	1830	32	50	6,9	13,8	5	20
<b>BMA 500x300-1000x150</b>	0,0813	990	1970	32	51	7,2	14,3	5	20
<b>BMA 800x200-400x400</b>	0,0869	1050	2100	33	51	7,4	14,7	5	20
<b>BMA 600x300</b>	0,0980	1190	2370	33	52	7,9	15,7	5	20
<b>BMA 1000x200-500x400</b>	0,1092	1320	2640	34	52	8,3	16,5	5	20
<b>BMA 700x300</b>	0,1147	1390	2780	34	53	8,5	17,0	5	20
<b>BMA 800x300-600x400</b>	0,1315	1590	3180	35	53	9,1	18,1	5	20
<b>BMA 700x400</b>	0,1537	1860	3720	35	54	9,8	19,6	5	20
<b>BMA 1000x300</b>	0,1649	2000	3990	36	54	10,2	20,3	5	20
<b>BMA 800x400</b>	0,1760	2130	4260	36	55	10,5	21,0	5	20
<b>BMA 1000x400</b>	0,2206	2670	5330	37	56	11,8	23,5	5	20
<b>BMA 500x500</b>	0,1370	1660	3320	35	53	9,3	18,5	5	20
<b>BMA 600x500</b>	0,1649	2000	3990	36	54	10,2	20,3	5	20
<b>BMA 800x500</b>	0,2206	2670	5330	37	56	11,8	23,5	5	20
<b>BMA 1000x500</b>	0,2764	3340	6670	38	57	13,1	26,2	5	20